

| REV | DESCRIPTION | MARK |
|-----|---------------|------|
| X1 | first edition | |

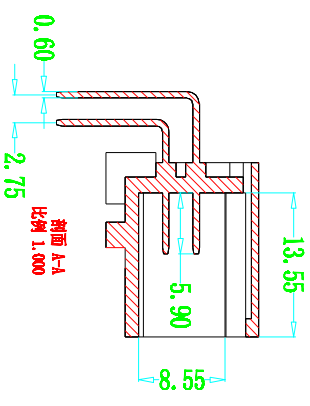
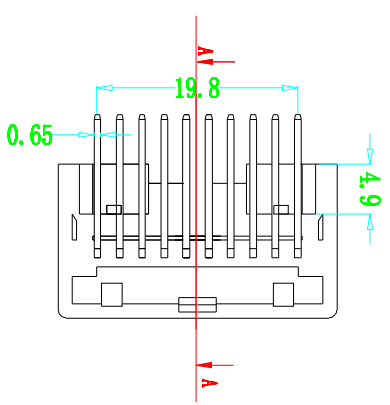
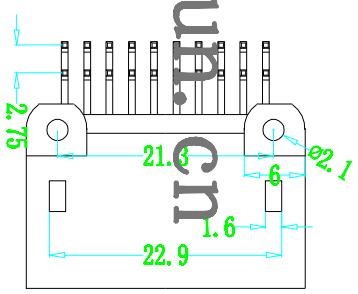
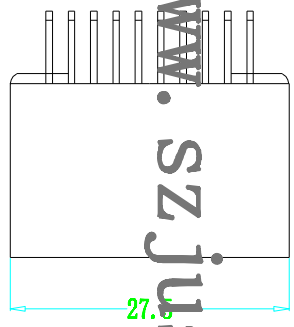
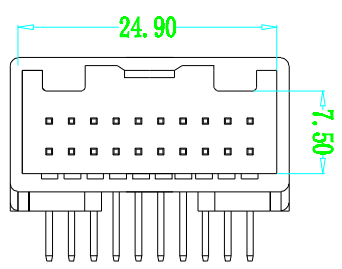
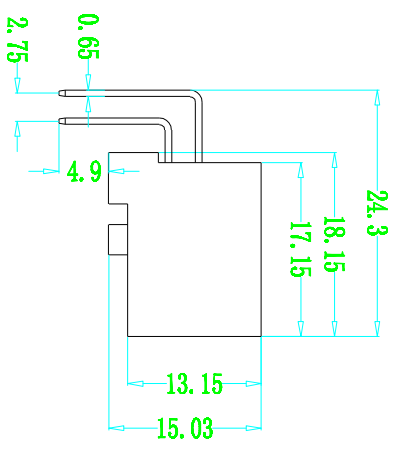
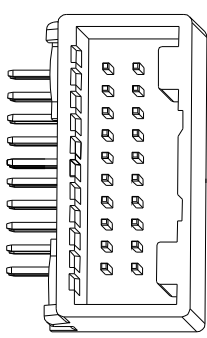

技术要求

- 1、未注公差按图纸左下角公差表制定;
- 2、符合GB2423.17中性盐雾试验要求;
- 3、未注圆角R0.2;
- 4、产品表面光滑,无裂纹,无毛刺,倒角清晰;

| | | | | | |
|--|---|--|--|-------------------------------------|---------|
| | | 钜赛实业(深圳)有限公司 JUSAI INDUSTRIAL (SHENZHEN) CO.,LTD | | PART NO.: 天麟-20P弯针 CUS PART NO.: | |
| $K \pm$ $.K \pm 0.30$ $.KK \pm 0.15$ $.XXX \pm$ | $K' \pm$ $.K' \pm 0.1^\circ$ $.KK' \pm 0.05^\circ$ $.XXX' \pm$ | MPT L FINISH QTY DR: | APPD: CHMD: DATE: 2017.09.05 SCALE: 1:1 | VERSION: V1.0 SHEET: 1/1 | REV: X1 |